

UTENSILI ANTISCINTILLA

SAFETY HAND TOOLS
SICHERHEITS-WERKZEUGE OUTILS ANTIETINCELANTS
HERRAMIENTAS ANTI-CHISPAS

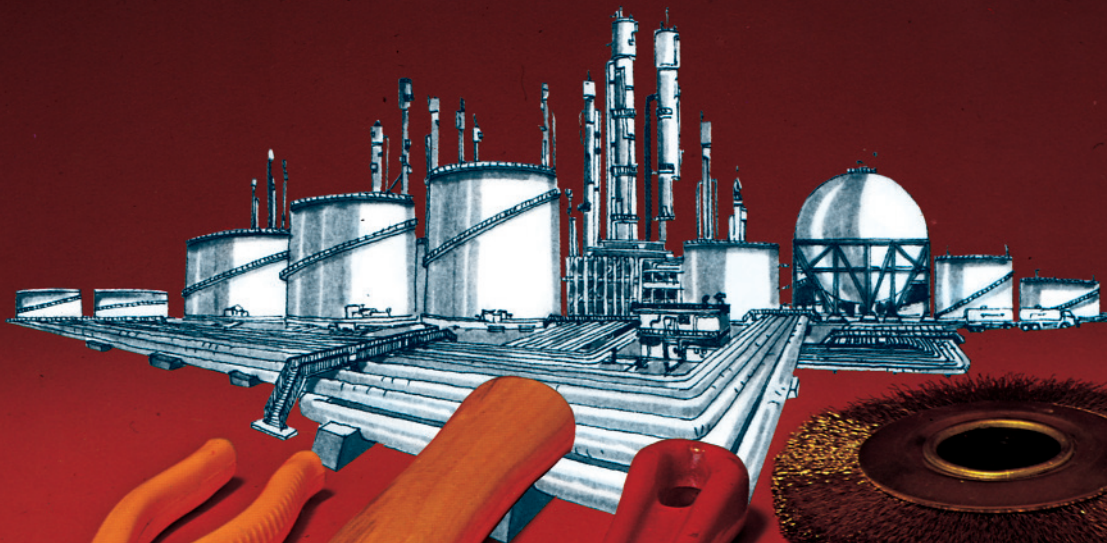

METALLURGICA MINOTTI

INDEX

Adapter	pag. 14	Kit Tool N. 1	pag. 30
Adjustable Hook Wrench	pag. 18	Kit Tool N. 2	pag. 31
Adjustable Wrench	pag. 19	Kit Tool N. 3	pag. 31
Adjustable Pipe Wrench (forged aluminium handle)	pag. 19	Kit Tool N. 4	pag. 15
Allen Wrench	pag. 17	Kit Tool N. 5	pag. 32
Anvil Bench and Stub	pag. 28	Kit Tool N. 6	pag. 33
Axe	pag. 27	Knife	pag. 26
Ball Peen	pag. 23	Light Chisel	pag. 24
Barrel Hook	pag. 29	Long Blade Scraper	pag. 21
Brush	pag. 27	Long Nose Plier With Cutting	pag. 20
Brush	pag. 28	Machinist's Hammer	pag. 23
Bull Point	pag. 25	Marking Tool	pag. 26
Bull Point	pag. 25	Offset Pin	pag. 26
Bung Wrench	pag. 18	Pick	pag. 27
Bung Wrench	pag. 18	Pick Scraper	pag. 22
Cape Chisel	pag. 24	Pinch Bar	pag. 26
Carbide Drum Opener	pag. 29	Pin Punch	pag. 25
Carpenters' Clamp	pag. 29	Pneumatic Scaling Chisel	pag. 25
Caulking Tool	pag. 24	Pneumatic Scaling Chisel	pag. 25
Chain	pag. 29	Point Chisel	pag. 24
Chain Block	pag. 29	Puncher	pag. 25
Chisel	pag. 24	Puncher	pag. 26
Combination Plier	pag. 19	Railroad Pick	pag. 27
Combination Wrench	pag. 13	Ratchet Handle	pag. 14
Concave Blade Tank Scraper	pag. 22	Round Nose Plier	pag. 19
Concrete Chisel	pag. 25	Round Shovel	pag. 26
Crow Bar	pag. 27	Scaling Hammer	pag. 23
Cutting Plier	pag. 20	Scraper	pag. 22
Deck Scraper	pag. 22	Screw Driver	pag. 20
Diagonal Cutting Plier	pag. 20	Screw Driver Phillips	pag. 21
Double Face Round Hammer	pag. 23	Sledge Hammer	pag. 23
Double Head Ring Wrench, Flat	pag. 13	Sliding Bar	pag. 14
Double Head Ring Wrench, Offset	pag. 12	Snap Riveting Hammer	pag. 24
Dust Pan	pag. 27	Socket, 6 - Point	pag. 13
Engineers Wrench, Double Head Open	pag. 12	Spray Booth Scraper	pag. 22
Engineers Wrench, Single Head Open	pag. 12	Square Shovel	pag. 26
Extension Bar	pag. 14	Stiff Blader Scraper	pag. 21
Flat Nose Plier	pag. 19	Striking Ring Wrench	pag. 16
Flat Scraper	pag. 21	Striking Wrench, Open ended	pag. 16
Floor Scraper	pag. 22	Tee Handle Square Drive	pag. 14
Gaspiper Plier	pag. 20	Tee Screw Driver	pag. 21
Groove Joint Plier	pag. 19	Tee Wrench Triangular	pag. 17
Hack Saw Blade	pag. 29	Tinner Snip	pag. 20
Hack Saw Frame	pag. 28	Triangular Blade Scraper	pag. 21
Half Flexibal Blade Scraper	pag. 21	Triangular Scraper	pag. 22
Hatchet	pag. 27	Universal Bung Wrench	pag. 18
Hinged Handle	pag. 14	Valve Key	pag. 18
Hook Wrench	pag. 18	Vice Bench (Parallel)	pag. 28
Kit no. 1	pag. 17	Wedge	pag. 24
		Wheel Brush	pag. 28
		Wrench Socket "L"	pag. 15
		Wrecking Bar	pag. 26

AGAINST RISKS OF EXPLOSION AND FIRE

METALMINOTTI spark-free, amagnetic and corrosion-proof hand-tools made out of **MZW** and **CuBe** alloy allow to work safely in all those working environments, where suitable steps are to be taken for the protection against explosions and fire.

In particular, they find an application in petrolchemical refineries, oil-tankers, gasworks, ammunition plants, navy, and all other places involved by the presence of hazardous elements such as: inflammable materials, gases, explosives, sea-water, etc.

The life of workmen and technicians is sometimes endangered by the sparks developed by steel-tools, whose use is notoriously unsafe in such environments.

In order to avoid irretrievable damages to persons and things, Boards for the Prevention of Accidents, Assistance and Assurance Institutions prescribe the use of safety tools.

METALMINOTTI safety hand-tools; i.g.: *wrenches, sledges, hammers, vices, hatchets, etc.* are made out of **MZW** alloy.

Screw-drivers and "cutting-tools", i.e. *chisels, knives, pliers, punches* are made out of **CuBe** alloy.

METALMINOTTI safety hand-tools are proof against corrosion, rust, acids, sea-water, etc.

They perfectly meet technical and mechanical prescriptions they have been studied and carried out for. Their mechanical features, comparable to those of the best steel alloys, are guarantee on long-life tools.

MAINTENANCE OF METALMINOTTI SAFETY TOOLS

Safety hand-tools, as well as steel tools, may undergo slight deformations caused by wear or improper use. Such deformations are easily removed by refacing both plain and sharp parts of the tools, either by filing, grinding or resharpening.

Tools out of **MZW** and **CuBe** alloy are to be refaced or adjusted at room temperature.

Refacing by grinding is to be carried out as wet, avoiding the tools to be heated over 200°C.

Overheating would compromise the hardness of the tools and make them of no use.

Safety hand-tools made out of MZW and CuBe alloy are guaranteed against any defect, for their quality and processing are strictly tested in fabrication.

HOMOLOGATIONS AND PATENTS

"MZ" alloys - Patent No. 515490 of 15.02.1955

Italian Military Navy - Homologation No. 39042 of 18.05.1956

E.N.P.I. (Italian Board for the Prevention of Accidents) - Homologation C.C.T. No. 1385 of 28.05.1964

Names and trademarks registered under No. 120242 of 27.12.1954 and No. 121526 of 23.02.1955

Certification OSVEDCENI FTZÚ 98 Ex 0285 - 03.03.1998

Certification KDB Poland N° 96.380 / T-2262 - 29.08.1996

MAIN USERS OF SPARK-FREE TOOLS:

• Chemical Industries • Petrochemical Industries • Pharmaceutical Industries • Paper-making Industries • Wine Industries • Alcohol Industries • Glue-making Factories • Paint and enamel Industries • Ink Industries • Mines • Oil and methane wells • Refineries • Gas deposits • Petrochemical Industries • Powder Magazines • Ammunition factories - Explosive works • Nuclear Industries • Telecommunication Companies • electrical Companies • Electronic Industries • Navy • Armament Industry • Tank-cleaner Companies • Tanneries • Distilleries

MAIN USERS OF AMAGNETIC TOOLS:

• Mine-sweepers • Hospitals (i.g. computer-processed axial tomography) • Radar transmission centers • Nuclear testing machines.

001 CHIAVE FISSA A DOPPIA APERTURA

ENGINEERS WRENCH, DOUBLE HEAD OPEN
DOPPELMAULSCHLÜSSEL
CLE A FOURCHE DOUBLE PLATE
LLAVE FIJA DE DOS BOCAS

MZW



	COD.	mm.	L mm.	g.
001	0607	6 x 7	125	50
	0809	8 x 9	145	50
	1011	10 x 11	160	75
	1213	12 x 13	175	100
	1415	14 x 15	210	220
	1417	14 x 17	210	220
	1617	16 x 17	210	220
	1719	17 x 19	225	300
	1819	18 x 19	225	300
	1922	19 x 22	245	300
	2022	20 x 22	245	300
	2123	21 x 23	245	300
	2224	22 x 24	245	350
	2426	24 x 26	270	600
	2427	24 x 27	270	600
	2528	25 x 28	270	600
	2729	27 x 29	270	600
	2730	27 x 30	270	600
	2732	27 x 32	305	800
	3032	30 x 32	305	800
	3036	30 x 36	330	1150
	3236	32 x 36	330	1150
	3538	35 x 38	340	1300
	3638	36 x 38	360	1350
	3641	36 x 41	360	1350
	4146	41 x 46	380	1400
	4650	46 x 50	410	1700
	5055	50 x 55	470	2300
	5560	55 x 60	570	5200
	6065	60 x 65	570	5200

002 CHIAVE FISSA A UNA BOCCA

ENGINEERS WRENCH, SINGLE HEAD OPEN
EINMAULSCHLÜSSEL
CLE A FOURCHE SIMPLE PLATE
LLAVE FIJA DE UNA BOCA

MZW



	COD.	mm.	L mm.	g.
002	0006	6	110	30
	0007	7	110	30
	0008	8	110	30
	0009	9	110	40
	0010	10	110	40
	0011	11	110	50
	0012	12	125	50
	0013	13	140	100
	0014	14	140	100

	COD.	mm.	L mm.	g.
002	0015	15	140	100
	0016	16	140	100
	0017	17	155	150
	0018	18	155	150
	0019	19	155	150
	0020	20	155	150
	0021	21	215	200
	0022	22	215	300
	0023	23	215	300
	0024	24	215	300
	0025	25	215	300
	0026	26	215	300
	0027	27	240	400
	0028	28	240	400
	0029	29	240	400
	0030	30	240	500
	0032	32	240	600
	0036	36	240	900
	0038	38	240	900
	0041	41	335	1100
	0046	46	410	1300
	0050	50	410	1400
	0055	55	410	2000
	0060	60	600	3400
	0065	65	600	3400

003 CHIAVE POLIGONALE CURVA

DOUBLE HEAD RING WRENCH, OFFSET
DOPPELRINGSCHLÜSSEL, 12-KANT GEKROPFT
CLE POLYGONALE CONTRE COUDEE
LLAVE ESTRELLA ACODADA

MZW



	COD.	mm.	L mm.	g.
003	0607	6 x 7	160	80
	0809	8 x 9	160	80
	1011	10 x 11	175	100
	1213	12 x 13	190	120
	1415	14 x 15	220	150
	1416	14 x 16	220	200
	1417	14 x 17	240	200
	1617	16 x 17	240	200
	1618	16 x 18	240	200
	1719	17 x 19	265	300
	1819	18 x 19	265	300
	1922	19 x 22	280	400
	2022	20 x 22	280	400
	2123	21 x 23	290	400
	2224	22 x 24	290	400
	2426	24 x 26	330	600
	2427	24 x 27	330	600
	2528	25 x 28	330	600
	2629	26 x 29	330	600
	2729	27 x 29	330	650
	2730	27 x 30	330	850
	2732	27 x 32	350	850
	3032	30 x 32	350	850
	3236	32 x 36	415	1200
	3641	36 x 41	415	1300
	4146	41 x 46	415	1450
	4650	46 x 50	430	1450
	5060	50 x 60	450	1550

004 CHIAVE POLIGONALE DIRITTA

DOUBLE HEAD RING WRENCH, FLAT
DOPPELRINGSCHLÜSSEL, GERADE
CLE POLYGONALE DROITE
LLAVE ESTRELLA PLANA

MZW



	COD.	mm.	L mm.	g.
004	0607	6 x 7	120	20
	0810	8 x 10	130	30
	0911	9 x 11	145	30
	1315	13 x 15	185	70
	2426	24 x 26	260	200
	2528	25 x 28	270	240
	5055	50 x 55	420	1500
	5560	55 x 60	480	2200
	6065	60 x 65	500	3200

023 CHIAVE COMBINATA

COMBINATION WRENCH
RING-MAULSCHLÜSSEL
CLE MIXTE
LLAVE COMBINADA

MZW



	COD.	mm.	L mm.	g.
023	0010	10	150	60
	0011	11	150	70
	0012	12	190	110
	0013	13	190	110
	0014	14	190	110
	0015	15	210	200
	0016	16	210	200
	0017	17	210	200
	0018	18	230	220
	0019	19	230	220
	0020	20	255	220
	0021	21	255	350
	0022	22	255	350
	0023	23	255	350
	0024	24	270	400
	0027	27	280	500
	0030	30	300	650
	0032	32	310	650
	0036	36	330	850
0041	41	405	2000	
0046	46	405	2000	

042 CHIAVE ESAGONALE A BUSSOLA

SOCKET, 6-POINT
STECKSCHLÜSSELEINSATZ, 6-KANT
DOUILLE CARRE 6-PANS
LLAVE DE VASO

MZW

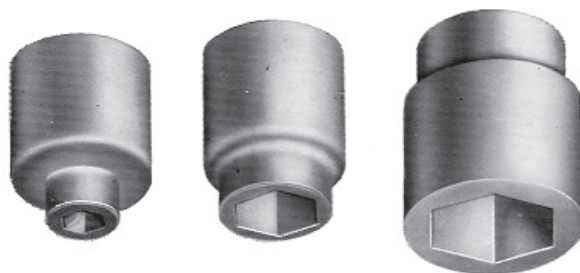

	COD.	mm.	mm.	g.
042	0812	8	1/2"	120
	0912	9	1/2"	130
	1012	10	1/2"	120
	1034	10	3/4"	120
	1112	11	1/2"	120
	1134	11	3/4"	120
	1212	12	1/2"	120
	1234	12	3/4"	120
	1312	13	1/2"	120
	1334	13	3/4"	130
	1412	14	1/2"	120
	1434	14	3/4"	130
	1512	15	1/2"	120
	1534	15	3/4"	130
	1612	16	1/2"	120
	1634	16	3/4"	120
	1712	17	1/2"	170
	1734	17	3/4"	170
	1812	18	1/2"	180
	1834	18	3/4"	180
	1912	19	1/2"	180
	1934	19	3/4"	180
	2012	20	1/2"	180
	2034	20	3/4"	180
	2112	21	1/2"	180
	2134	21	3/4"	180
	2212	22	1/2"	180
	2234	22	3/4"	180
	2312	23	1/2"	180
	2334	23	3/4"	180
	2412	24	1/2"	180
	2434	24	3/4"	180
	2512	25	1/2"	190
2534	25	3/4"	190	
2612	26	1/2"	200	
2634	26	3/4"	200	
2712	27	1/2"	200	
2734	27	3/4"	200	
2812	28	1/2"	230	
2834	28	3/4"	200	
2912	29	1/2"	200	
2934	29	3/4"	230	
3012	30	1/2"	220	
3034	30	3/4"	230	
3212	32	1/2"	320	
3234	32	3/4"	450	
3434	34	3/4"	450	
3534	35	3/4"	450	
3634	36	3/4"	450	
3834	38	3/4"	490	
4134	41	3/4"	600	
4634	46	3/4"	600	
5034	50	3/4"	650	
5534	55	3/4"	650	

I prezzi riportati sul nostro listino sono validi solo se da noi confermati.
Si forniscono utensili anche a disegno.
Consultateci per qualunque problema; Vi aiuteremo.
Vi preghiamo menzionare su ordini e/o RdO il nostro codice riferimento articolo.

	COD.	mm.	mm.	g.
042	5834	58	3/4"	750
	6034	60	3/4"	750
	6534	65	3/4"	760
	7034	70	3/4"	870
	7534	75	3/4"	1000
	8034	80	3/4"	1120
	7001	70	1"	
	7501	75	1"	
	8001	80	1"	
	8501	85	1"	
	9001	90	1"	
	1001	100	1"	
	7012	5/16"	1/2"	
	7112	3/8"	1/2"	
	7212	7/16"	1/2"	
	7312	1/2"	1/2"	
	7412	9/16"	1/2"	
	7512	19/32"	1/2"	
	7612	5/8"	1/2"	
	7712	11/16"	1/2"	
	7812	3/4"	1/2"	
	7912	25/32"	1/2"	
	8012	13/16"	1/2"	
	8112	7/8"	1/2"	
	8212	15/16"	1/2"	
	8312	1"	1/2"	
	8412	1-1/16"	1/2"	
	8512	1-1/8"	1/2"	
	8612	1-1/4"	1/2"	
	8712	1-1/2"	1/2"	

corrispondenti a misure decimali
equals to decimal sizes

421

PROLUNGA FISSA
TEE HANDLE SQUARE DRIVE
VERLÄNGERUNG
RALLONGE FIXE
ALARGADERA FIJA

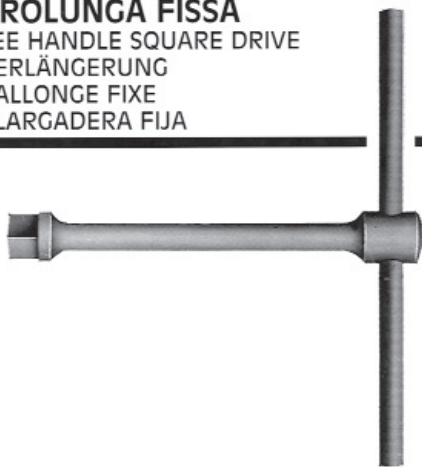

MZW

	COD.	mm.	L mm.	g.
421	0012	1/2"	245	500
	0034	3/4"	260	850

422

PROLUNGA CON SNODO
HINGED HANDLE
GELENKGRIF
POIGNEE ARTICULEE
ALARGADERA ARTICULADA



MZW

	COD.	mm.	L mm.	g.
422	0012	1/2"	215	350
	0034	3/4"	375	1000

423

CRICCHETTO
RATCHET HANDLE
KNARRE
CLE A CLIQUET
LLAVE DE CARRACA

MZW



	COD.	mm.	L mm.	g.
423	0012	1/2"	250	650
	0025	1"	420	2000
	0034	3/4"	420	1950

424

ADATTATORE
ADAPTER
ANPASSUNGSTEIL
ADAPTEUR
ALARGADERA CORTO

MZW

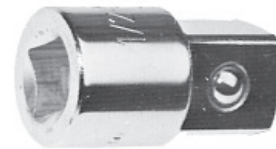

	COD.	mm.	L mm.	g.	
424	0012	1/2"	3/4"	50	200
	0034	3/4"	1/2"	50	200

425

PROLUNGA A "T"
SLIDING BAR
QUERGRIF MIT AUßENVIERKANT
POIGNEE COULISSANTE
LLAVE DE MANGO

MZW



	COD.	mm.	L mm.	g.
425	0012	1/2"	320	550
	0034	3/4"	500	1600

426

PROLUNGA
EXTENSION BAR
QUERGRIF
RALLONGE
ALARGADERA

MZW



	COD.	mm.	L mm.	g.
426	0012	1/2"	125	200
	0121	1/2"	250	400
	0034	3/4"	200	600
	0134	3/4"	380	1100

300**CASSETTA N. 4**

KIT TOOL No. 4
 WERKZEUGKASTEN 4
 BOITE A OUTILS 4
 CAJA DE HERRAMIENTAS 4

MZW

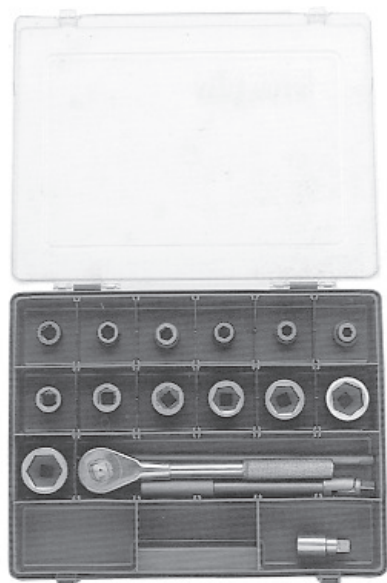

	COD.	Cont.	COD.	L mm.	H mm.	P mm.	kg.
300	1000			380	60	300	4,7
		Nr.pz.	1 4230012				
			1 4220012				
			1 4250012				
			1 0423212				
			1 0423012				
			1 0422712				
			1 0422412				
			1 0422212				
			1 0421912				
			1 0421712				
			1 0421512				
			1 0421412				
			1 0421312				
			1 0421212				
			1 0421112				
			1 0421012				

I prezzi riportati sul nostro listino sono validi solo se da noi confermati

Si forniscono utensili anche a disegno.

Consultateci per qualunque problema; Vi aiuteremo.

Vi preghiamo menzionare su ordini e/o RdO il nostro codice riferimento articolo.

Prices shown on our price-list are valid only after our confirmation.

We can supply tools also according to drawing.

Ask for us in any need; we shall help you.

Please quote our "Code reference" on your orders and/or enquiries.

Die Verkaufspreise sind nur nach unserer Bestätigung gültig.

Es werden auch Sonderwerkzeuge nach Zeichnung hergestellt.

Wenden Sie Sich an uns für alle Ihre Erfordernisse; wir helfen ihnen gerne.

005**CHIAVI A PIPA**

WRENCH SOCKET "L"
 STECKSCHLÜSSEL, SECHSKANT
 CLE A PIPE 6 PANS
 LLAVE EXAGONAL A PIPA

MZW

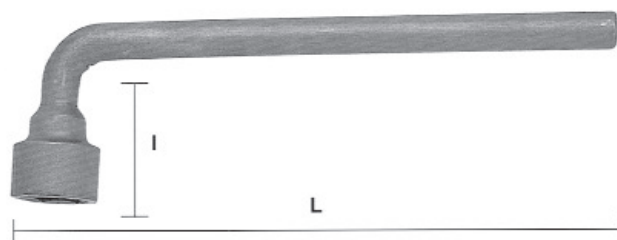

	COD.	mm.	L mm.	I mm.	g.
005	0008	8	115	55	150
	0009	9	120	55	150
	0010	10	125	55	200
	0011	11	130	55	200
	0012	12	140	55	300
	0013	13	150	55	300
	0014	14	160	55	400
	0017	17	200	60	600
	0019	19	210	60	600
	0022	22	245	60	600
	0024	24	270	65	650
	0027	27	270	65	650
	0030	30	300	65	800
	0032	32	310	65	800
	0036	36	320	80	1300
	0041	41	320	80	1300

Beim Bestellen oder Anfragen, bitte die artikel nummer angeben.

Les prix de notre tarif sont valables seulement après notre confirmation.

Nous pouvons fournir outils suivant plan.

Consultez nous pour V/besoins et nous Vous aiderons.

Merci de mentioner sur vos commandes et/ou demandes de prix notre "Code" de référence article.

Los precios de nuestra lista de precios son validos si estan confirmados por nosotros.

Se puede suministrar herramientas de acuerdo con su disenno.

Consultenos su problema; le ayudaremos.

Al pasar su pedidos o consultas indique por favor el numero de "Codigo" de referencia del articulo.

047 CHIAVE FISSA PER PERCUSSIONE

STRIKING WRENCH, OPEN ENDED
MAULSCHLÜSSEL
CLE A FRAPPER FIXE
LLAVE FIJA DE GOLPE

MZW



	COD.	mm.	L mm.	g.
047	0024	24	160	400
	0027	27	160	400
	0030	30	180	700
	0032	32	180	700
	0036	36	180	700
	0041	41	240	1300
	0046	46	240	1300
	0050	50	280	2800
	0055	55	280	2800
	0060	60	280	2800
	0065	65	340	4800
	0070	70	340	4800
	0075	75	340	4800
	0080	80	410	6800
	0085	85	410	6800
	0090	90	410	6800
	0095	95	430	9500
	0100	100	430	9500
	0105	105	430	9500
	0110	110	500	17200
	0115	115	550	17200
	0120	120	550	17200
	0125	125	550	21000
	0130	130	600	21000
	0135	135	600	21000
	0140	140	600	29000
	0145	145	650	29000
	0150	150	650	29000

048 CHIAVE ESAGONALE POLIGONALE PER PERCUSSIONE

STRIKING RING WRENCH
RINGSCHLAGSCHLÜSSEL
CLE EXAGONAL A FRAPPER
LLAVE HEXAGONAL DE GOLPE

MZW



	COD.	mm.	L mm.	g.
048	0019	19	150	350
	0022	22	150	350
	0024	24	150	350
	0027	27	150	350
	0030	30	170	600
	0032	32	170	600
	0036	36	170	600
	0041	41	230	1300
	0046	46	230	1300
	0050	50	265	1800
	0055	55	265	1800
	0060	60	300	3300
	0065	65	300	3300
	0070	70	320	4700
	0075	75	320	4700
	0080	80	320	4700
	0085	85	360	6200
	0090	90	360	6200
	0095	95	360	6200
	0100	100	390	8200
	0105	105	390	8200
	0110	110	390	8200
	0115	115	430	10000
	0120	120	430	10000
	0125	125	430	10000
	0130	130	460	12500
	0135	135	460	12500
	0140	140	460	12500
	0145	145	500	15000
	0150	150	500	15000
	0155	155	500	15000

I prezzi riportati sul nostro listino sono validi solo se da noi confermati. Si forniscono utensili anche a disegno.

Consultateci per qualunque problema; Vi aiuteremo.

Vi preghiamo menzionare su ordini e/o RdO il nostro codice riferimento articolo.

Prices shown on our price-list are valid only after our confirmation.

We can supply tools also according to drawing.

Ask for us in any need; we shall help you.

Please quote our "Code reference" on your orders and/or enquiries.

Die Verkaufspreise sind nur nach unserer Bestätigung gültig.

Es werden auch Sonderwerkzeuge nach Zeichnung hergestellt.

Wenden Sie Sich an uns für alle Ihre Erfordernisse; wir helfen ihnen gerne.

Beim Bestellen oder Anfragen, bitte.

Les prix de notre tarif sont valables seulement après notre confirmation.

Nous pouvons fournir outils suivant plan.

Consultez nous pour V/besoins et nous Vous aiderons.

Merci de mentionner sur vos commandes et/ou demandes de prix notre "Code" de référence article.

Los precios de nuestra lista de precios son validos si estan confirmados por nosotros.

Se puede suministrar herramientas de acuerdo con su diseño.

Consultenos su problema; le ayudaremos.

Al pasar su pedidos o consultas indique por favor el numero de "Codigo" de referencia del articulo.

060**CHIAVE PER BULLONI A CAVA
ESAGONALE**

ALLEN WRENCH
WINKELSCHRAUBENDREHER
CLE MALE COUDEE
DESTORNILLADOR HEXAGONAL ACODADO MZW



	COD.	mm.	g.
060	0015	1,5	5
	0020	2	5
	0025	2,5	5
	0030	3	5
	0040	4	10
	0050	5	15
	0060	6	25
	0070	7	50
	0080	8	60
	0090	9	70
	0100	10	100
	0110	11	130
	0120	12	165
	0130	13	200
	0140	14	250
	0170	17	420
	0190	19	600
	0220	22	950
	0240	24	1250
	0270	27	1800
	0300	30	2500
	0320	32	3100
	0360	36	4500

I prezzi riportati sul nostro listino sono validi solo se da noi confermati. Si forniscono utensili anche a disegno. Consultateci per qualunque problema; Vi aiuteremo. Vi preghiamo menzionare su ordini e/o RdO il nostro codice riferimento articolo.

Prices shown on our price-list are valid only after our confirmation. We can supply tools also according to drawing. Ask for us in any need; we shall help you. Please quote our "Code reference" on your orders and/or enquiries.

Die Verkaufspreise sind nur nach unserer Bestätigung gültig. Es werden auch Sonderwerkzeuge nach Zeichnung hergestellt. Wenden Sie Sich an uns für alle Ihre Erfordernisse; wir helfen ihnen gerne. Beim Bestellen oder Anfragen, bitte.

Les prix de notre tarif sont valables seulement après notre confirmation. Nous pouvons fournir outils suivant plan. Consultez nous pour V/besoins et nous Vous aiderons. Merci de mentioner sur vos commandes et/ou demandes de prix notre "Code" de référence article.

Los precios de nuestra lista de precios son validos si estan confirmados por nosotros. Se puede suministrar herramientas de acuerdo con su diseno. Consultenos su problema; le ayudaremos. Al pasar su pedidos o consultas indique por favor el numero de "Codigo" de referencia del articulo.

100**KIT N. 1**

KIT No. 1
KIT 1
KIT 1
KIT 1

MZW

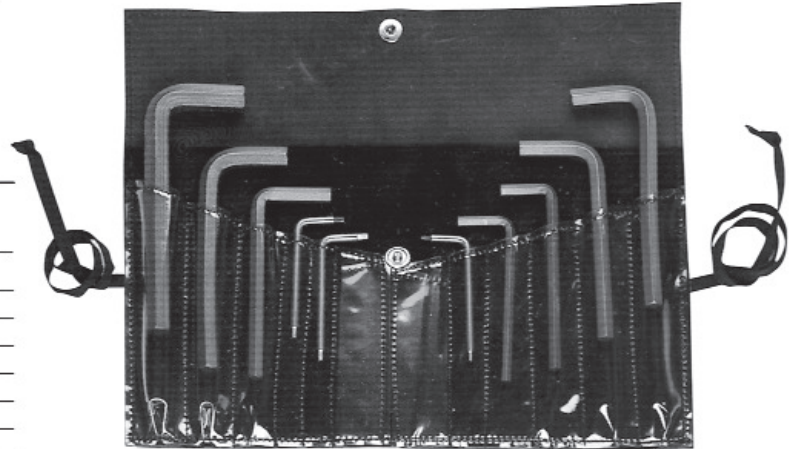

	COD.	Cont.	COD.	L mm.	H mm.	g.
100	1000			290	230	600
		Nr.pz.	1 060-0020			
			1 060-0030			
			1 060-0040			
			1 060-0050			
			1 060-0060			
			1 060-0070			
			1 060-0080			
			1 060-0090			
			1 060-0100			
			1 060-0120			

062**CHIAVE A CAVA TRIANGOLARE**

TEE WRENCH TRIANGULAR
DREIKANTSTECKSCHLÜSSEL
CLE A EMPREINTE TRIANGULAIRE
LLAVE DE TUBO DE BOCA
TRIANGULAR DE MULETILLA

MZW



	COD.	mm.	L mm.	g.
062	0004	M4	95	80
	0005	M5	110	100
	0006	M6	115	170
	0008	M8	125	280
	0010	M10	140	390
	0012	M12	160	700
	0016	M16	180	980
	0020	M20	200	2100
	0024	M24	220	3100

050 CHIAVE A SETTORE FISSA

HOOK WRENCH
HAKENSCHLÜSSEL
CLE A ERGOT
LLAVE DE MEDIO PUNTO

MZW



	COD.	Ø mm.	L mm.	g.
050	3436	34/36	170	100
	4042	40/42	170	100
	4550	45/50	205	150
	5255	52/55	205	150
	5862	58/62	240	310
	6875	68/75	240	310
	8090	80/90	280	390
	9510	95/100	280	390
	9700	110/115	330	660

063 CHIAVE A SETTORE CON SNODO

ADJUSTABLE HOOK WRENCH
GELENKSCHLÜSSEL
CLE A ERGOT ARTICULE
LLAVE AJSTABLE

MZW



	COD.	mm.	L mm.	g.
063	3810	Ø38/100	300	600

069 CHIAVE PER VALVOLE

VALVE KEY
VENTILHAKEN
CLE A VOLANT
LLAVE PARA VALVULAS

MZW

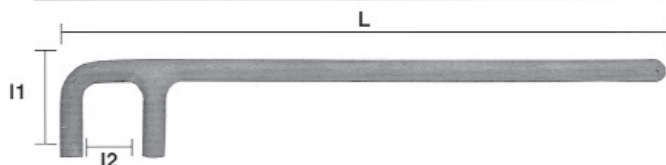

	COD.	Ø mm.	L mm.	I1	I2	g.
069	0400	16	400	65	40	400

I prezzi riportati sul nostro listino sono validi solo se da noi confermati
Si forniscono utensili anche a disegno.
Consultateci per qualunque problema; Vi aiuteremo.
Vi preghiamo menzionare su ordini e/o RdO il nostro codice riferimento articolo.

Prices shown on our price-list are valid only after our confirmation.
We can supply tools also according to drawing.
Ask for us in any need; we shall help you.

043 APRIFUSTI

BUNG WRENCH
SCHLÜSSEL FÜR FABVERSCHLÜSSE
CLE A BONDE
LLAVE DE BARILLES

MZW



	COD.	mm.	L mm.	g.
043	0380	380	380	1200

064 APRIFUSTI CON ATTACCO QUADRO

BUNG WRENCH
VIERKANTSCHLÜSSEL
CLE A BONDE
LLAVE DE BARILLES

MZW



	COD.	A mm.	L mm.	g.
064	0020	20	300	1000
	0022	22	300	1300
	0024	24	350	1800
	0027	27	350	2300
	0032	32	400	3700

065 APRIFUSTI UNIVERSALE

UNIVERSAL BUNG WRENCH
SCHLÜSSEL FÜR FABVERSCHLÜSSE
CLE A BONDE UNIVERSELLE
LLAVE DE BARILLES

MZW



	COD.	mm.	L mm.	g.
065	0380	380	380	1250

Please quote our "Code reference" on your orders and/or enquiries.

Die Verkaufspreise sind nur nach unserer Bestätigung gültig.
Es werden auch Sonderwerkzeuge nach Zeichnung hergestellt.
Wenden Sie Sich an uns für alle Ihre Erfordernisse; wir helfen ihnen gerne.
Beim Bestellen oder Anfragen, bitte.

Les prix de notre tarif sont valables seulement après notre confirmation.
Nous pouvons fournir outils suivant plan.
Consultez nous pour V/besoins et nous Vous aiderons.
Merci de mentionner sur vos commandes et/ou demandes de prix notre "Code" de référence article.

012 CHIAVE A RULLINO "CRESCENT"

ADJUSTABLE WRENCH
 ROLLGABELSCHLÜSSEL
 CLE A MOLLETTE
 LLAVE CON MOLETA

MZW



	COD.	L mm.	g.	apertura max. mm.
012	2000	200	245	22
	2500	250	920	27
	3000	300	1320	30
	3800	380	1700	44

061 GIRATUBI

ADJUSTABLE PIPE WRENCH (forged aluminium handle)
 VERSTELLBARER ROHRSCHLÜSSEL (Leichtmetall)
 CLE A TUBE
 LLAVE PARA TUBOS

MZW



	COD.	L mm.	g.	apertura max. mm.
061	3500	350	1000	60
	4500	450	1600	75
	6000	600	2500	100
	9000	900	5200	140

006 PINZA UNIVERSALE

COMBINATION PLIER
 KOMBINATIONSZANGE
 PINCE UNIVERSELLE
 ALICATE UNIVERSALE

Cu-Be

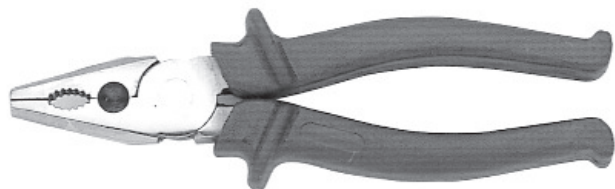

	COD.	L mm.	g.
006	2000	200	325

Los precios de nuestra lista de precios son validos si estan confirmados por nosotros.
 Se puede suministrar herramientas de acuerdo con su diseno.
 Consultenos su problema; le ayudaremos.
 Al pasar su pedidos o consultas indique por favor el numero de "Codigo" de referencia del articulo.

007 TENAGLIOLO A BECCHI TONDI

ROUND NOSE PLIER
 RUNDZANGEN
 PINCE A BECS RONDOS
 ALICATE, BOCAS REDONDAS

Cu-Be



	COD.	L mm.	g.
007	1600	160	135

008 TENAGLIOLO A BECCHI PIATTI

FLAT NOSE PLIER
 FLACHZANGEN
 PINCE A BECS PLATS
 ALICATE, BOCAS PLANAS

Cu-Be



	COD.	L mm.	g.
008	1600	160	150

013 PINZA REGOLABILE PER DADI E TUBI

GROOVE JOINT PLIER
 WASSERPUMPENZANGE
 PINCE MULTI-PRISES
 TENAZA POLISIADORA

CUBE

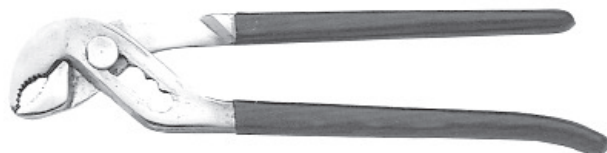

	COD.	L mm.	g.	apertura max. mm.
013	2400	240	305	40

I prezzi riportati sul nostro listino sono validi solo se da noi confermati. Si forniscono utensili anche a disegno.
 Consultateci per qualunque problema; Vi aiuteremo.
 Vi preghiamo menzionare su ordini e/o RdO il nostro codice riferimento articolo.

Prices shown on our price-list are valid only after our confirmation.
 We can supply tools also according to drawing.
 Ask for us in any need; we shall help you.
 Please quote our "Code reference" on your orders and/or enquiries.

Die Verkaufspreise sind nur nach unserer Bestätigung gültig.
 Es werden auch Sonderwerkzeuge nach Zeichnung hergestellt.
 Wenden Sie Sich an uns für alle Ihre Erfordernisse; wir helfen ihnen gerne.
 Beim Bestellen oder Anfragen, bitte.

014 PINZA PER GASISTA

GASPIPE PLIER
GASROHRZANGE
PINCE POUR GAZIER
TENAZA DE GASISTA

MZW



	COD.	L mm.	g.	apertura max. mm.
014	2100	210	370	40

067 CESCOIA

TINNER SNIP
BLECHSCHERE
CISAILLES
CIZALLA

MZW

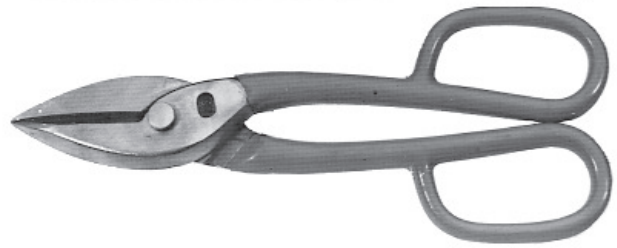

	COD.	L mm.	g.
067	2800	280	700

036 TENAGLIA

CUTTING PLIER
BEISSZANGE
TENAILLES
TENAZA

MZW

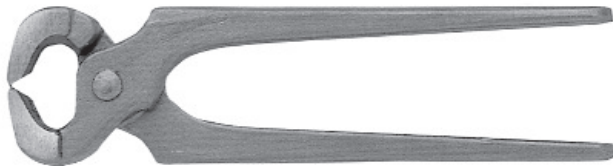

	COD.	L mm.	g.
036	1800	180	250

068 PINZA PER TELEFONISTI

LONG NOSE PLIER WITH CUTTING
TELEFONZANGE
PINCE COUPANTE D'ELECTRICIEN
TENAZA PARA TELEFONISTA

Cu-Be

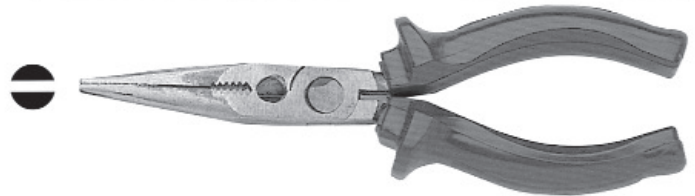

	COD.	L mm.	g.
068	1800	180	150

066 TRONCHESE

DIAGONAL CUTTING PLIER
SEITENSCHNEIDER
PINCE COUPANTE EN DIAGONAL
CORTA ALAMBRES

Cu-Be

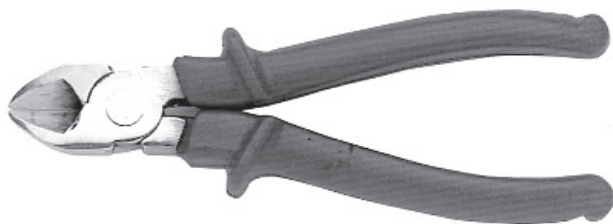

	COD.	L mm.	g.
066	1600	160	100

021 CACCIAVITE

SCREWDRIVER
SCHRAUBENDREHER
TOURNEVIS
DESTORNILLADOR

Cu-Be



	COD.	A	B	C	D	g.	g.
021	0150	150	60	4	4	50	
	0180	180	85	5	5	60	
	0220	220	115	6	6	80	
	0250	250	130	6	6	100	
	0280	280	160	9	8	180	
	0300	300	170	10	8	190	

Les prix de notre tarif sont valables seulement après notre confirmation. Nous pouvons fournir outils suivant plan. Consultez nous pour V/besoins et nous Vous aiderons. Merci de mentionner sur vos commandes et/ou demandes de prix notre "Code" de référence article.

Los precios de nuestra lista de precios son validos si estan confirmados por nosotros. Se puede suministrar herramientas de acuerdo con su diseno. Consultenos su problema; le ayudaremos. Al pasar su pedidos o consultas indique por favor el numero de "Codigo" de referencia del articulo.

I prezzi riportati sul nostro listino sono validi solo se da noi confermati. Si forniscono utensili anche a disegno. Consultateci per qualunque problema; Vi aiuteremo. Vi preghiamo menzionare su ordini e/o RdO il nostro codice riferimento articolo.

Prices shown on our price-list are valid only after our confirmation. We can supply tools also according to drawing. Ask for us in any need; we shall help you. Please quote our "Code reference" on your orders and/or enquiries.

059**CACCIAVITE A CROCE**

SCREWDRIVER PHILLIPS
 KREUZSCHLITZSCHRAUBENDREHER
 TOURNEVIS PHILLIPS
 DESTORNILLADOR



Cu-Be

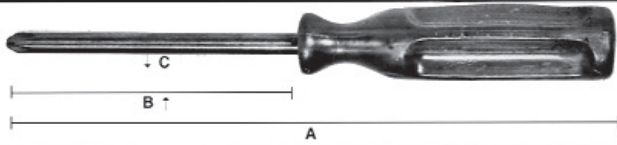

	COD.	GRD.Nr.	A	B	C	g.	👤
059	1150	1	150	60	4,5	50	
	2200	2	200	95	6	65	
	3250	3	250	130	8	110	
	4300	4	300	170	10	200	

071**SPATOLA SEMIFLESSIBILE**

HALF FLEXIBAL BLADE SCRAPER
 SPACHTEL, FLEXIBLES BLATT
 GRATTOIR FLEXIBLE
 ESPATULA HOJA FLEXIBLE

Cu-Be



	COD.	A.	g.
071	0040	40	120
	0060	60	180
	0080	80	200
	0100	100	220

022**CACCIAVITE A "T"**

TEE SCREWDRIVER
 SCHRAUBENDREHER
 TOURNEVIS
 DESTORNILLADOR

MZW

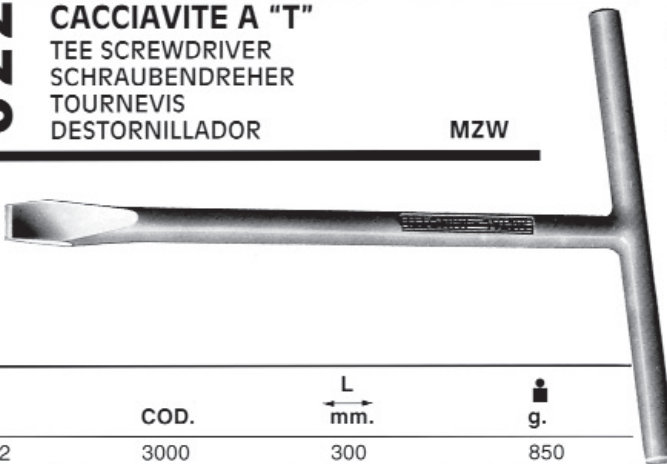

	COD.	L mm.	g.
022	3000	300	850

072**SPATOLA LUNGA**

LONG BLADE SCRAPER
 SPACHTELMESSER
 SPATULE A MELANGER
 ESPATULA PARA MEZOLAR

Cu-Be



	COD.	L mm.	g.
072	3500	350	90

044**SPATOLA RIGIDA**

STIFF BLADER SCRAPER
 SPACHTEL, STARRES BLATT
 GRATTOIR RIGIDE
 ESPATULA HOJA RIGIDA

MZW

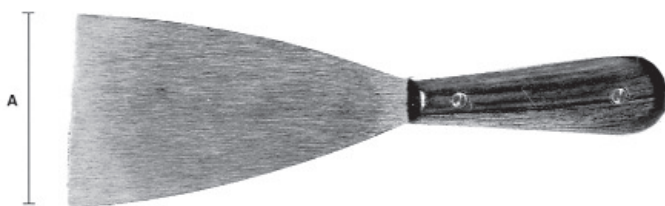

	COD.	A.	g.
044	0030	30	100
	0040	40	120
	0060	60	180
	0080	80	200
	0100	100	250
	0220	220	340

073**RASCHIETTO A LAMA PIATTA**

FLAT SCRAPER
 FLACHSCHABER
 GRATTOIR PLAT
 RASCADOR PLANO

MZW



	COD.	L mm.	g.
073	3150	315	210

074**RASCHIETTO A LAMA TRIANGOLARE**

TRIANGULAR BLADE SCRAPER
 SCHABER, DREIKANTBLATT
 LAME TRIANGULAIRE
 RASCADOR HOJA TRIANGULAR

MZW



	COD.	L mm.	g.
074	3100	310	200

Die Verkaufspreise sind nur nach unserer Bestätigung gültig.
 Es werden auch Sonderwerkzeuge nach Zeichnung hergestellt.
 Wenden Sie sich an uns für alle Ihre Erfordernisse; wir helfen ihnen gerne.
 Beim Bestellen oder Anfragen, bitte.

040 RASCHIETTO A ZAPPETTADECK SCRAPER
WINKELSCHABER
GRATTOIR A LAME COUDEE
RASQUETA

MZW



	COD.	L mm.	g.
040	0255	255	480

045 RASCHIETTOSCRAPER
SCHABER
GRATTOIR
RASCADOR

MZW

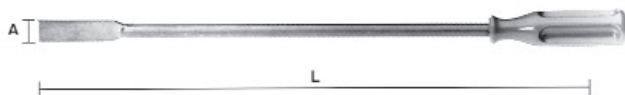

	COD.	A	L mm.	g.
045	5400	20	540	450

055 RASCHIATOIO A MANOSPRAY BOOTH SCRAPER
HANDSCHABER
GRATTOIR DE PEINTRE
RASCADOR

MZW



	COD.	A.	L mm.	g.
055	8000	80	225	450

070 RASCHIETTO A TESTA TRIANGOLARETRIANGULAR SCRAPER
DREIKANTSCHABER
GRATTOIR TRIANGULAIRE
RASCADOR TRIANGULAR

MZW



	COD.	L mm.	g.
070	5000	440	600

053 RASCHIAPARETIFLOOR SCRAPERS
STOBSCHABER
GRATTOIR A TRACHANT
RASCADOR

MZW



	COD.	A.	g.
053	1000	100	900
	1500	150	1300

076 SCROSTATOIO A LAMA CONCAVACONCAVE BLADE TANK SCRAPER
SCHABER, HOHLBLATT
GRATTOIR LAME CONCOVE
RASCADOR HOJA CONCAVA

MZW

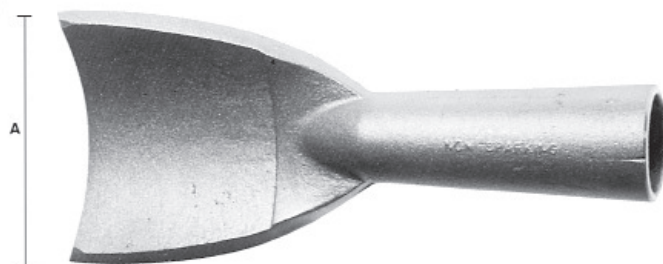

	COD.	A.	g.
076	1000	100	900
	1500	150	1350

077 SCROSTATOIO A MARTELLINAPICK SCRAPER
REINIGUNGSWERKZEUG
PIC A GRATTOIR
RASCADOR CON PICO

MZW

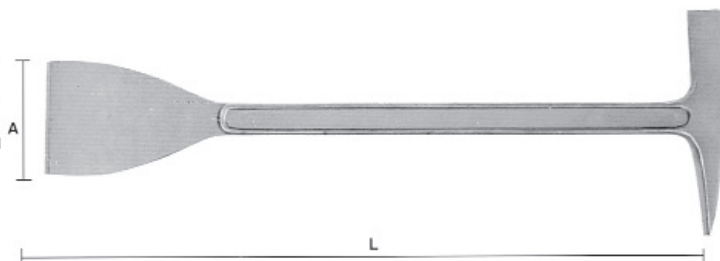

	COD.	L mm.	A	g.
077	4800	480	80	1250

Les prix de notre tarif sont valables seulement après notre confirmation. Nous pouvons fournir outils suivant plan. Consultez nous pour V/besoins et nous Vous aiderons. Merci de mentionner sur vos commandes et/ou demandes de prix notre "Code" de référence article.

019 MARTELLINA SCROSTATOIO

SCALING HAMMER
ENTROSTUNGSHAMMER
MARTEAU A PIQUER
MARTILLO BURILADOR

MZW

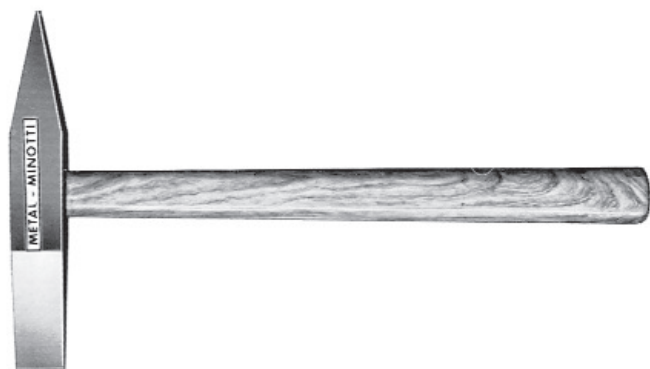

	COD.	g.
019	0500	500

015 MARTELLO MACHINIST'S HAMMER HAMMER MARTEAU RIVOIR MARTILLO

MZW



	COD.	g.
015	0300	300
	0500	500
	0800	800
	1000	1000
	1500	1500
	2000	2000

016 MARTELLO PER LATTONIERE

DOUBLE FACE ROUND HAMMER
MASCHINISTENHAMMER
MARTEAU POUR FERBLANTIER
MARTILLO PARA LATONERO

MZW



	COD.	g.
016	0300	300
	0500	500
	0900	900

017 MARTELLO PER IMBUTTITURA

BALL PEEN
SCHLOSSERHAMMER
MARTEAU D'AJUSTER
MARTILLO DE BOLA

MZW



	COD.	g.
017	0150	150
	0300	300
	0500	500
	0800	800
	1000	1000
	1500	1500
	2000	2000

018 MAZZETTA, MAZZA

SLEDGE HAMMER
FAUSTEL
MASSE A PANS
MAZA

MZW



	COD.	g.	
018	0050	500	} Manico corto Short handle
	0100	1000	
	0150	1500	
	0200	2000	
	0300	3000	} Manico lungo Long handle
	0400	4000	
	0500	5000	
	0600	6000	
	0800	8000	
	1000	10000	

Los precios de nuestra lista de precios son validos si estan confirmados por nosotros.

Se puede suministrar herramientas de acuerdo con su diseno.

Consultenos su problema; le ayudaremos.

Al pasar su pedidos o consultas indique por favor el numero de "Codigo" de referencia del articulo.

I prezzi riportati sul nostro listino sono validi solo se da noi confermati. Si forniscono utensili anche a disegno.

Consultateci per qualunque problema; Vi aiuteremo.

Vi preghiamo menzionare su ordini e/o RdO il nostro codice riferimento articulo.

Prices shown on our price-list are valid only after our confirmation.

We can supply tools also according to drawing.

Ask for us in any need; we shall help you.

Please quote our "Code reference" on your orders and/or enquiries.

046 MARTELLLO RIBATTITORE
 SNAP RIVETING HAMMER
 SCHLAGHAMMER
 MARTEAU REPOUSSEUR
 MARTILLO PUNZON **MZW**



	COD.	g.
046	1000	1000

024 SCALPELLO
 CHISEL
 MEIBEL
 BURIN
 CORTAFRIO **MZW**



	COD.	L mm.	mm.	g.
024	0150	150	14	180
	0175	175	17	330
	0200	200	17	330
	0250	250	17	580
	0300	300	19	700
	0350	350	22	1000
	0400	400	24	1400
	0450	450	24	1530

241 SCALPELLO A PUNTA
 POINT CHISEL
 SPITZMEIBEL
 BURIN A POINTE
 CORTAFRIO **MZW**



	COD.	L mm.	mm.	g.
241	0150	150	14	180
	0175	175	17	330
	0200	200	17	330
	0250	250	17	580
	0300	300	19	700
	0350	350	22	1000
	0400	400	24	1400
	0450	450	24	1530

025 SCALPELLO A UNGHIA
 CAPE CHISEL
 KREUZMEIBEL
 BEDANE
 CORTAFRIO **Cu-Be**



	COD.	L mm.	g.
025	1750	175	200
	2000	200	490

026 SCALPELLO LEGGERO
 LIGHT CHISEL
 MEIBEL, LEICHT
 BURIN LEGER
 CORTAFRIO **Cu-Be**



	COD.	L mm.	mm.	g.
026	0150	150	14	170
	0200	200	14	300
	0250	250	17	550
	0300	300	17	650
	0350	350	19	1000
	0400	400	22	1500
	0450	450	22	1700

041 CUNEO
 WEDGE
 KEIL
 COIN
 CUNA **MZW**



	COD.	L mm.	A.	H mm.
041	1050	100	50	10
	1325	150	25	13
	1330	150	30	13
	1340	150	40	13
	2040	230	40	20
	4040	230	40	40

049 CALCASTOPPA
 CAULKING TOOL
 STEMMWERKZEUG
 MATOIR
 BURIL **MZW**

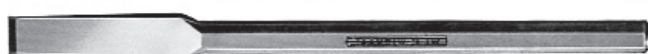

	COD.	L mm.	g.
049	2650	265	260

083 SCALPELLO PER CEMENTO

CONCRETE CHISEL
 BETONMEIßEL
 CISEAU POUR BETON
 CORTAFRIO PARA CEMENTO

MZW



	COD.	L mm.	g.
083	0039	390	3500

084 PUNTA PER MARTELLO PNEUMATICO

BULL POINT
 PREBLUFTSPITZMEIßEL
 PIC POUR OUTIL PNEUMATIQUE
 PUNTA PARA MARTILLO NEUMATICO

MZW



	COD.	mm.	L mm.	g.
084	0450	25,4 (1")	450	1800

085 PUNTA PER MARTELLO PNEUMATICO

BULL POINT
 PREBLUFTSPITZMEIßEL
 PIC POUR OUTIL PNEUMATIQUE
 PUNTA PARA MARTILLO NEUMATICO

MZW

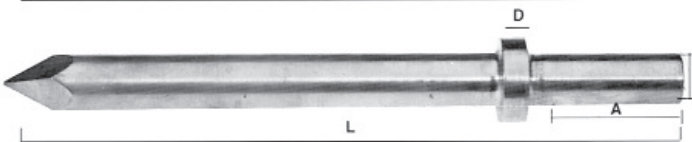

	COD.	Ø D	Ø d	A	L mm.	g.
085	3300	40	25	65	330	1300
	4300	40	25	65	430	1750
	5300	40	25	65	530	2150

087 SCALPELLO PER UTENSILI PNEUMATICI

PNEUMATIC SCALING CHISEL
 PREBLUFTMEIßEL
 CISEAU POUR OUTIL PNEUMATIQUE
 CORTAFRIO PARA HERRAMIENTA NEUMATICA Cu-Be

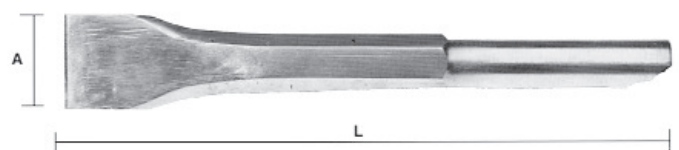

	COD.	Ø mm.	L mm.	A	g.
087	4500	17,3	200	30	520

088 SCALPELLO PER UTENSILI PNEUMATICI

PNEUMATIC SCALING CHISEL
 PREBLUFTMEIßEL
 CISEAU POUR OUTIL PNEUMATIQUE
 CORTAFRIO PARA HERRAMIENTA NEUMATICA

MZW

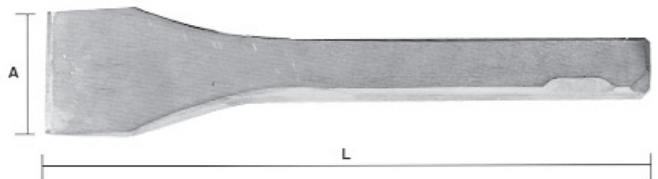

	COD.	L mm.	■	A	g.
088	0140	140	13	30	180

081 PUNZONE

PUNCHER
 DURCHTREIBER KONISCH
 CHASSE POINTS CONIQUE
 BOTEROS

MZW



	COD.	Ø mm.	L mm.	g.
081	0020	2	120	120
	0030	3	120	120
	0040	4	120	120
	0050	5	120	120
	0060	6	120	120
	0080	8	150	200
	0100	10	175	300
	0120	12	175	450
	0160	16	175	900
	0200	20	250	1250
	0250	25	250	2200

082 CACCIA COPPIGLIE

PIN PUNCH
 SPLINTTREIBER ZYLINDRISCH
 CHASSE-GOUPILLES CYLINDRIQUE
 GOZNES

MZW



	COD.	Ø mm.	L mm.	g.
082	0300	3	150	60
	0400	4	150	140
	0500	5	150	140
	0600	6	150	120
	0700	7	150	150
	0800	8	150	190
	1000	10	160	260
	1200	12	180	330
	1600	16	200	430

Die Verkaufspreise sind nur nach unserer Bestätigung gültig.
 Es werden auch Sonderwerkzeuge nach Zeichnung hergestellt.
 Wenden Sie sich an uns für alle Ihre Erfordernisse; wir helfen ihnen gerne.
 Beim Bestellen oder Anfragen, bitte.

037 **PUNTERUOLO**
PUNCHER
DURCHTREIBER
POINTEAU
PUNZON (granete)

Cu-Be



	COD.	L mm.	g.
037	0100	100	50
	0145	145	80

089 **PUNZONE PIEGATO**
OFFSET PIN
WINKELDORN
POINTEAU COUDE
PUNZON ACODADO

MZW



	COD.	L mm.	g.
089	0330	300	600
	0450	450	1000

090 **TRACCIATORE**
MARKING TOOL
REIßNADEL
POINT A TRACER
TRAZADOR

Cu-Be



	COD.	L mm.	g.
090	1900	190	50

075 **COLTELLO**
KNIFE
MESSER
COUPEAU
COUCHILLO

Cu-Be



	COD.	L mm.	g.
075	1800	180	90

079 **LEVACHIODI**
WRECKING BAR
HEBESTANGE MIT NAGELKLAUE
PINCE A DECOFFRER
PALANCA

MZW



	COD.	L mm.	mm.	g.
079	0450	450	17	900
	0600	600	17	1500
	0750	750	22	2700
	0900	900	22	3400

080 **LEVA**
PINCH BAR
BRECHSTANGE
PINCE A TALON
PALANCA

MZW



	COD.	L mm.	mm.	g.
080	0450	450	17	800
	0600	600	17	1400
	0750	750	22	2500
	0900	900	22	3600

091 **PALA**
SQUARE SHOVEL
RANDSCHAUFEL
PELLE DE CHAUFFRE
PALA

MZW



	COD.	L mm.	Dimensioni pala	g.
091	1300	1300	220 x 310	2000

093 **BADILE**
ROUND SHOVEL
SCHAUFEL
PELLE DE TERRASSIER
PALA

MZW



	COD.	L mm.	Dimensioni badile	g.
093	1300	1300	250 x 280	2000

094 **PALETTA**
DUST PAN
HANDSCHAUFEL
PELLE
PALA DE MANO

MZW

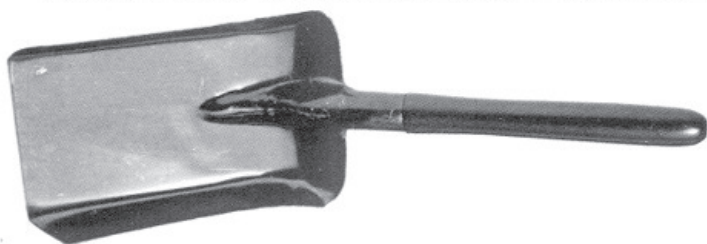

COD.	L mm.	Dimensioni pala	g.
094	450	120 x 200	400

034 **PICCONE**
PICK
SPITZHACKE
PIC
PICO

MZW



COD.	L mm.	g.
034	560	2300

341 **PICCONE**
RAILROAD PICK
KREUZHACKE
PIC
PICO

MZW



COD.	L mm.	g.
0341	580	2400

039 **PALANCHINO**
CROW BAR
HEBESTANGE
BRAS DE LEVIER
PALANCA

MZW



COD.	L mm.	g.
039	650	2000
	800	2900
	1000	4300
	1250	7000
	1500	9000

020 **ASCIA**
AXE
AXT
HACHE
HACHA

MZW



COD.	L mm.	g.
020	900	3000

033 **ACCETTA**
HATCHET
BEIL
HACHETTE
HACHUELA

MZW



COD.	L mm.	g.
033	450	1000
	450	1500

054 **SPAZZOLA CON MANICO**
BRUSH
BÜRSTE
BROSSE
CEPILLO

MZW

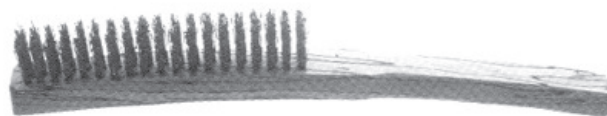

COD.	L mm.	g.
054	350	200

Les prix de notre tarif sont valables seulement après notre confirmation. Nous pouvons fournir outils suivant plan. Consultez nous pour V/besoins et nous Vous aiderons. Merci de mentionner sur vos commandes et/ou demandes de prix notre "Code" de référence article.

Los precios de nuestra lista de precios son validos si estan confirmados por nosotros. Se puede suministrar herramientas de acuerdo con su diseno. Consultenos su problema; le ayudaremos. Al pasar su pedidos o consultas indique por favor el numero de "Codigo" de referencia del articulo.

541 SPAZZOLA
BRUSH
BÜRSTE
BROSSE
CEPILLO

MZW



	COD.	A.	L mm.	g.
541	1800	67	180	300

096 SPAZZOLA ROTANTE
WHEEL BRUSH
RUNDBÜRSTE
BROSSE ROTANTE
CEPILLO ROTANTE

MZW



	COD.	D Ø mm.	d Ø MM	g.
096	0150	150	22	650

027 MORSA DA BANCO
VICE BENCH (Parallel)
SCHRAUBSTOCK
ETAU A BANC
TORNILLO DE BANCO

MZW

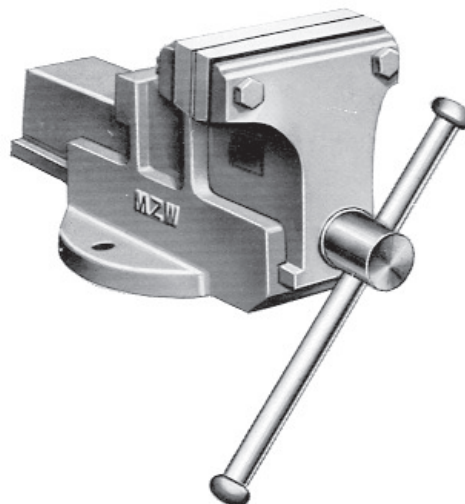

	COD.	Larghezza ganasse mm.	Apertura max. mm.	g.
027	0090	90	100	6500

028 INCUDINE DA BANCO O DA CEPPO
ANVIL BENCH AND STUB
AMBOß
ENCLUME A BANC ET A BILLOR
YUNQUE

MZW

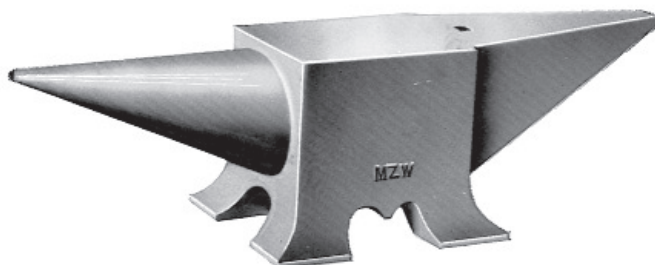

	COD.	kg.
028	1400	14
	2500	25

030 SEGHETTO A MANO
HACK SAW FRAME
BÜGELSÄGE
SCIE A MAIN EXTENSIBLE
ARCO DE SIERRA

MZW



	COD.	L mm.	g.
030	0550	550	900

098 LAMA PER SEGHETTO A MANO
 HACK SAW BLADE
 SÄGEBLATT
 LAME DE SCIE
 LAMA PARA ARCO DE SIERRA Cu-Be



	COD.	L mm.	g.
098	0300	300	30

035 SERGENTE
 CARPENTERS' CLAMP
 SCHRAUBZWINGE
 SERRE-JOINT
 SARGENTO DE APRIETE MZW



	COD.	L mm.	Apertura max. mm.	g.
035	0180	180	80	3160
	0250	250	120	4230
	0430	430	270	13500

095 TAGLIAFUSTI
 CARBIDE DRUM OPENER
 KARBIDTROMMELÖFFNER
 TONNEAU A CARBURE
 CUCHILLO PARA CARBON MZW



	COD.	L mm.	g.
095	3000	300	750

I prezzi riportati sul nostro listino sono validi solo se da noi confermati
 Si forniscono utensili anche a disegno.
 Consultateci per qualunque problema; Vi aiuteremo.
 Vi preghiamo menzionare su ordini e/o RdO il nostro codice riferi-
 mento articolo.

We can supply tools also according to drawing.
 Ask for us in any need; we shall help you.
 Please quote our "Code reference" on your orders and/or enquiries.

029 PARANCO A MANO
 CHAIN BLOCK
 FLASCHENZUG
 PALAN A CHAINE
 POLIPASTO MZW

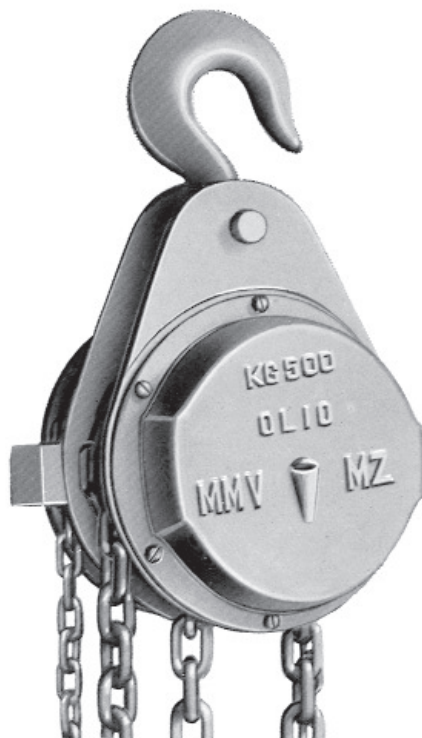

	COD.	Portata kg.	Catena manovra	Catena sollevam.	g.
029	0500	500	5 x 28	8 x 38	22

291 CATENA
 CHAIN
 KETTEN
 CHAINE
 CADENA MZW

	COD.	Misura maglia
291	0528	5 x 28
	0838	8 x 38
	1254	12 x 54

099 GANCI PER BIDONI
 BARREL HOOK
 FASHEBER
 CROCHETS POUR TONEAUX
 GANCHOS PARA BARRIL MZW



	COD.	Portata kg.	g.
099	0600	600	3800

200 KIT N. 2

KIT
KIT
KIT
KIT

MZW

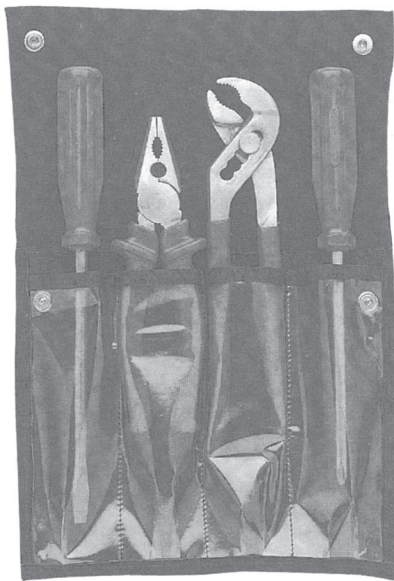

	COD.	Cont.	COD.	L mm.	H mm.	kg.
200	1000			250	250	1
		Nr.pz.	1 0210280			
			1 0593250			
			1 0132400			
			1 0062000			

I prezzi riportati sul nostro listino sono validi solo se da noi confermati. Si forniscono utensili anche a disegno. Consultateci per qualunque problema; Vi aiuteremo. Vi preghiamo menzionare su ordini e/o RdO il nostro codice riferimento articolo.

Prices shown on our price-list are valid only after our confirmation. We can supply tools also according to drawing. Ask for us in any need; we shall help you. Please quote our "Code reference" on your orders and/or enquiries.

Die Verkaufspreise sind nur nach unserer Bestätigung gültig. Es werden auch Sonderwerkzeuge nach Zeichnung hergestellt. Wenden Sie Sich an uns für alle Ihre Erfordernisse; wir helfen ihnen gerne. Beim Bestellen oder Anfragen, bitte.

Les prix de notre tarif sont valables seulement après notre confirmation. Nous pouvons fournir outils suivant plan. Consultez nous pour V/besoins et nous Vous aiderons. Merci de mentioner sur vos commandes et/ou demandes de prix notre "Code" de référence article.

Los precios de nuestra lista de precios son validos si estan confirmados por nosotros. Se puede suministrar herramientas de acuerdo con su diseno. Consultenos su problema; le ayudaremos. Al pasar su pedidos o consultas indique por favor el numero de "Codigo" de referencia del articulo.

600 CASSETTA N. 1

KIT TOOL No. 1
WERKZEUGKASTEN 1
BOITE A OUTILS 1
CAJA DE HERRAMIENTAS 1

MZW

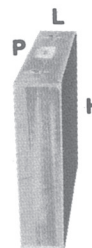
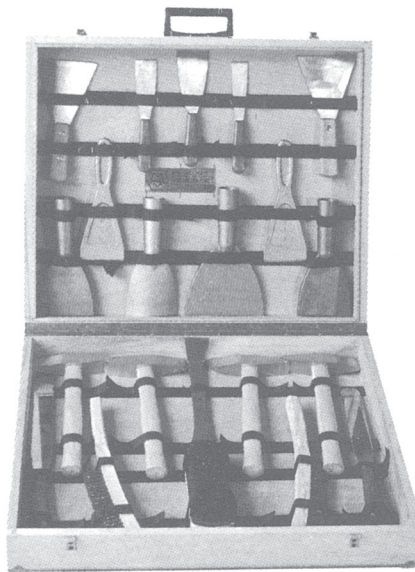

	COD.	Cont.	COD.	L mm.	H mm.	P mm.	kg.
600	1000			640	145	540	20
		Nr.pz.	4 0190500				
			1 0400255				
			2 0558000				
			2 0531000				
			1 0440030				
			2 0440110				
			2 0543500				
			1 5411800				
			1 0531500				
			1 0761000				
			1 0440040				
			1 0440060				
			2 0722800				

700**CASSETTA N. 2**

KIT TOOL No. 2
 WERKZEUGKASTEN 2
 BOITE A OUTILS 2
 CAJA DE HERRAMIENTAS 2

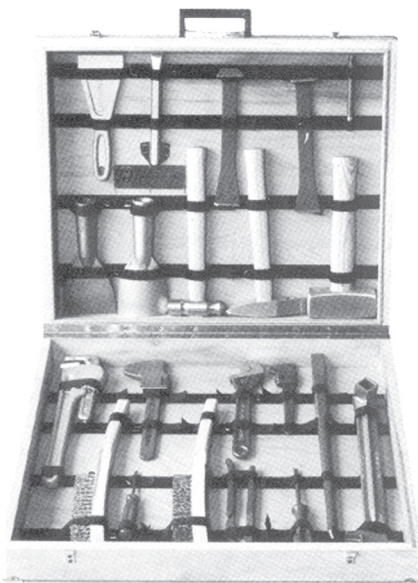
MZW**800****CASSETTA N. 3**

KIT TOOL No. 3
 WERKZEUGKASTEN 3
 BOITE A OUTILS 3
 CAJA DE HERRAMIENTAS 3

MZW

	COD.	Cont.	COD.	L mm.	H mm.	P mm.	kg.
700	2000			640	145	540	24
		Nr.pz. 2	0543500				
		1	0370145				
		1	0240200				
		1	0531000				
		1	0210150				
		1	0210220				
		1	0122500				
		1	0170500				
		1	0180200				
		2	0400255				
		1	0122000				
		1	0123800				
		1	0653800				
		1	0558000				
		1	0613500				
		1	0761000				
		1	0800450				

	COD.	Cont.	COD.	L mm.	H mm.	P mm.	kg.
800	3000			640	145	540	28
		Nr.pz. 1	0170500				
		1	0151000				
		1	0152000				
		1	0531000				
		1	0032123				
		1	0032729				
		1	0013641				
		1	0012427				
		1	0013236				
		1	0014146				
		1	0020027				
		1	0020032				
		1	0020036				
		1	0020041				
		1	0020046				
		1	0020050				
		1	0470055				
		1	0240200				
		1	0252000				
		2	0440030				
		1	0400255				
		1	0122500				
		1	0123000				
		1	0613500				
		1	0122000				
		1	0062000				
		1	0210150				
		1	0210220				
		1	0543500				
		1	5411800				
		1	0800450				

400**CASSETTA N. 5**

KIT TOOL No. 5
 WERKZEUGKASTEN 5
 BOITE A OUTILS 5
 CAJA DE HERRAMIENTAS 5

MZW

	COD.	Cont.	COD.	L mm.	H mm.	P mm.	kg.
400	2000			390	130	210	4
		Nr.pz.	1 0543500				
			1 5411800				
			1 0062000				
			1 0132400				
			1 0751800				
			1 0400255				
			1 0190500				
			1 0210280				
			1 0210180				
			1 0210220				
			1 0710080				
			1 0440060				
			1 0440040				

I prezzi riportati sul nostro listino sono validi solo se da noi confermati. Si forniscono utensili anche a disegno. Consultateci per qualunque problema; Vi aiuteremo. Vi preghiamo menzionare su ordini e/o RdO il nostro codice riferimento articolo.

Prices shown on our price-list are valid only after our confirmation. We can supply tools also according to drawing. Ask for us in any need; we shall help you. Please quote our "Code reference" on your orders and/or enquiries.

Die Verkaufspreise sind nur nach unserer Bestätigung gültig. Es werden auch Sonderwerkzeuge nach Zeichnung hergestellt. Wenden Sie sich an uns für alle Ihre Erfordernisse; wir helfen ihnen gerne.

Beim Bestellen oder Anfragen, bitte.

Les prix de notre tarif sont valables seulement après notre confirmation. Nous pouvons fournir outils suivant plan. Consultez nous pour V/besoins et nous Vous aiderons. Merci de mentionner sur vos commandes et/ou demandes de prix notre "Code" de référence article.

Los precios de nuestra lista de precios son validos si estan confirmados por nosotros. Se puede suministrar herramientas de acuerdo con su disenno. Consultenos su problema; le ayudaremos. Al pasar su pedidos o consultas indique por favor el numero de "Codigo" de referencia del articulo.

500**CASSETTA N. 6**

KIT TOOL No. 6

WERKZEUGKASTEN 6

BOITE A OUTILS 6

CAJA DE HERRAMIENTAS 6

MZW

	COD.	Cont.	COD.	L mm.	H mm.	P mm.	kg.
500	3000			420	230	230	11,5
		Nr.pz.	1 0650380				
			1 0613500				
			2 0543500				
			1 0122500				
			1 0122000				
			1 0132400				
			1 0062000				
			1 0240250				
			1 0240175				
			1 0411340				
			1 0150800				
			1 0170500				
			1 0558000				
			1 0440060				
			1 0440040				
			1 0013032				
			1 0012427				
			1 0012022				
			1 0011819				
			1 0011617				
			1 0011415				
			1 0011213				
			1 0011011				
			1 0010809				
			1 0010607				

I prezzi riportati sul nostro listino sono validi solo se da noi confermati. Si forniscono utensili anche a disegno. Consultateci per qualunque problema; Vi aiuteremo. Vi preghiamo menzionare su ordini e/o RdO il nostro codice riferimento articolo.

Prices shown on our price-list are valid only after our confirmation. We can supply tools also according to drawing. Ask for us in any need; we shall help you. Please quote our "Code reference" on your orders and/or enquiries.

Die Verkaufspreise sind nur nach unserer Bestätigung gültig. Es werden auch Sonderwerkzeuge nach Zeichnung hergestellt. Wenden Sie Sich an uns für alle Ihre Erfordernisse; wir helfen ihnen gerne.

Beim Bestellen oder Anfragen, bitte.

Les prix de notre tarif sont valables seulement après notre confirmation.

Nous pouvons fournir outils suivant plan.

Consultez nous pour V/besoins et nous Vous aiderons.

Merci de mentionner sur vos commandes et/ou demandes de prix notre "Code" de référence article.

Los precios de nuestra lista de precios son validos si estan confirmados por nosotros.

Se puede suministrar herramientas de acuerdo con su disenno.

Consultenos su problema; le ayudaremos.

Al pasar su pedidos o consultas indique por favor el numero de "Codigo" de referencia del articulo.

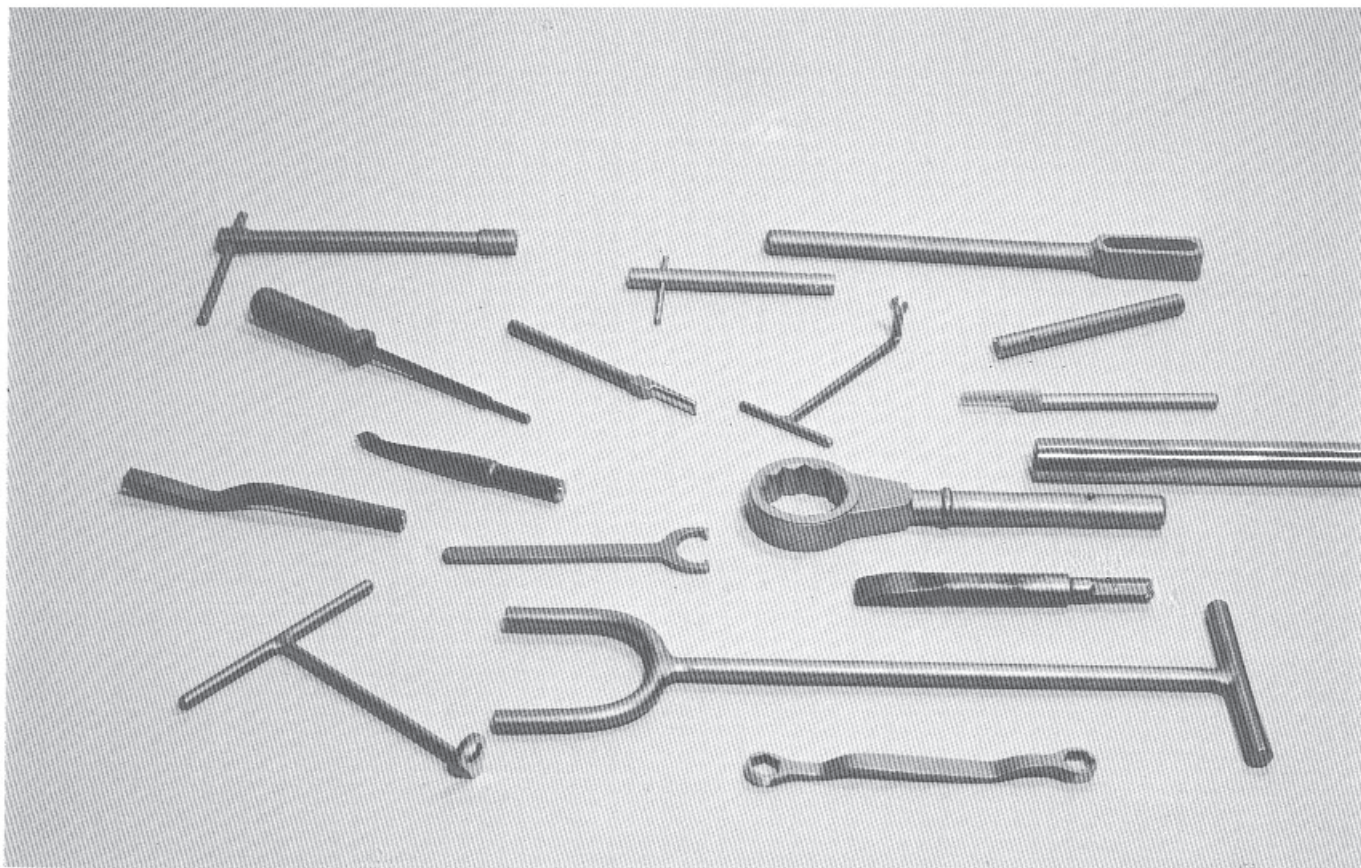

SI POSSONO FORNIRE UTENSILI SPECIALI A DISEGNO
 WE CAN SUPPLY HAND TOOLS ALSO ACCORDING YOUR DRAWINGS
 ES WERDEN AUCH SPEZIALWERKZEUGE NACH ZEICHNUNG HERGESTELLT
 NOUS POUVONS VOUS FOURNIR OUTILS SELON VOS CROQUIS
 SE PUEDEN SUMINISTRAR HERRAMIENTAS DE ACUERDO CON SU DISEÑO

I prezzi riportati sul nostro listino sono validi solo se da noi confermati
 Si forniscono utensili anche a disegno.
 Consultateci per qualunque problema; Vi aiuteremo.
 Vi preghiamo menzionare su ordini e/o RdO il nostro codice riferimento
 articolo.

Prices shown on our price-list are valid only after our confirmation.
 We can supply tools also according to drawing.
 Ask for us in any need; we shall help you.
 Please quote our "Code reference" on your orders and/or enquiries.

Die Verkaufspreise sind nur nach unserer Bestätigung gültig.
 Es werden auch Sonderwerkzeuge nach Zeichnung hergestellt.
 Wenden Sie Sich an uns für alle Ihre Erfordernisse; wir helfen ihnen
 gerne.

Beim Bestellen oder Anfragen, bitte.

Les prix de notre tarif sont valables seulement après notre confirma-
 tion.
 Nous pouvons fournir outils suivant plan.
 Consultez nous pour V/besoins et nous Vous aiderons.
 Merci de mentioner sur vos commandes et/ou demandes de prix notre
 "Code" de référence article.

Los precios de nuestra lista de precios son validos si estan confirma-
 dos por nosotros.
 Se puede suministrar herramientas de acuerdo con su diseno.
 Consultenos su problema; le ayudaremos.
 Al pasar su pedidos o consultas indique por favor el numero de
 "Codigo" de referencia del articulo.